

GÜHRING

Machining industry 2019

Spotlight on e-mobility: there is no future without a past



Hans-Peter Mögele (pictured right), Head of Tool Technology at GROB-WERKE GmbH & Co. KG, Achim Walker, Head of Original Equipment/OEM projects at Gühring KG.

The automotive industry is changing: alternative drive concepts such as the electric motor are putting brand new machining tasks on every supplier's agenda. Mechanical engineering firms and tool manufacturers have a duty to reliably manufacture e-components. The production and automation systems specialists at GROB-WERKE Mindelheim and tool manufacturer GÜHRING are an experienced and well-oiled team.

Manufacturers of e-components must have the international, professional expertise to overcome the special challenges inherent in e-mobility. Maximum efficiency and profitability, along with process reliability in component manufacturing, are particularly important in series production. One international automotive supplier has recognised this fact: GROB and GÜHRING were about to start implementing the large-scale series production of electric motor housings, complete with gearbox covers, for a renowned car manufacturer. The challenges this presents are the reliable manufacture of small diameter tolerances of up to IT6 and small geometric tolerances, such as concentricity of up to 40 µm with a reference length of more than 400 mm which was laterally inverted during machining. A perfect blend of machining centre and precision tools is essential for responding successfully to these challenges. For more than 90 years, GROB has been setting the bar in the construction of highly innovative production and automation systems. The Mindelheim-based company in turn places its trust in GÜHRING as a longstanding partner for original equipment and a leading manufacturer of rotating precision tools. It is a working relationship founded on tradition, expertise and trust. To offer even better support to GROB and its end customers with the daily demands of machining, last year GÜHRING opened a new centre for original equipment in Mindelheim, right on GROB-WERKE's doorstep.

Partner for the series production of e-motor components

GÜHRING is a longstanding supplier to the automotive industry and, like GROB, has outstanding production depth and an extremely comprehensive product portfolio. GROB is a pioneer in plant construction for the series manufacture of e-machines and electric motors. The customer is assured of cost-effective manufacture, taking account of the costs per component and minimum

cycle times for maximum output quantities. Stator bores, for instance, demand a high degree of measuring precision. With a diameter of 235 mm, the appropriate 6-axis GÜHRING PCD tool has a tilting moment of 22 Nm and weighs less than 20 kilograms. This lightweight tool is made from aluminium which, as well as reducing the spindle load, guarantees maximum productivity.

Design of holistic tool and machine concepts

GROB and GÜHRING deliver custom-made turnkey solutions tailored to the customer's specific needs: machines, processes, devices, tools and automation

assure the user of a holistic machining and tool concept. As an expert in all kinds of components, GROB works with the user to determine the optimum machining process and finalises the design of the tools with GÜHRING. The machining experts at both companies assure the user of the swift implementation of custom-made solutions of the highest quality. The client enjoys personal support, from the planning of the individual machining operations right through to acceptance of series production. GROB is able to illustrate every possible scenario, from the complete machining of the component in a single operation to fully automated machining in several clamping positions. Turning operations can also be reliably manufactured, either by using milling and turning centres or by using a feed-out spindle. Wherever you are in the world, GROB and GÜHRING have their own production sites and service centres close at hand, particularly in areas with a high density of automotive companies and their suppliers – guaranteeing quick response times and maximum customer proximity.

Wealth of experience goes into machining

GROB and GÜHRING are particularly skilled at tackling the individual requirements dictated by e-mobility. They draw on decades of experience in the automotive sector and the insights and achievements of their own research and development departments. GÜHRING, for example, boasts a huge amount of knowledge of the required precision tools. The Albstadt-based company has 40 years of experience in PCD (polycrystalline diamond), which it incorporates in the machining of e-motor housings, including thin-walled and large diameters of up to 300 mm coupled with small geometric tolerances, which are regularly encountered in the manufacture of gearbox housings. It also integrates the latest product innovations into e-machining. Preventive measures aimed at maximising process reliability, such as the FEM calculation during tool construction to reduce weight or rigidity and vibration tests taking account of real operating speeds, are an established part of the routine. Innovative tool geometries, included for defined chip evacuation thanks to additive manufacturing, in coolant duct connectors and cooling fins in the stator housing during milling, boring and reaming are part of the product portfolio.

GROB also boasts impressive, in-depth expertise in e-mobility: with over 90 years' experience in the system business, the company recognised early on the evolution in automotive drivetrains

and diversified its product portfolio accordingly, adopting a long-term strategy. This development was given a further, major boost by the takeover of DMG meccanica, the leading machinery and plant manufacturer for the production of stators for electric motors and generators in Italy and the construction of an ultra-modern development and applications centre. GROB is now able to offer its customers comprehensive support, from the initial idea to large series production of hybrid and electric drives.

All the components at a glance

Thanks to the strategic partnership formed by GROB and GÜHRING. Today reference customers are assured of the reliable series production of tens of thousands of e-motor components. In-house project groups and development teams at GROB and GÜHRING have been addressing the issue of e-mobility for many years. In constant dialogue with the automotive industry, a high demand for production facilities for mass production in the automotive industry was quickly identified. At GROB, the focus is on the core segments of electric motors and batteries. GROB already offers wave winding, hairpin, fan coil and inserting technology as well as needle winding technology. Because of this, it covers the entire electric motor manufacturing process, which includes the various winding and shaping procedures for the wires, assembly and also the contacts. GROB and GÜHRING are therefore able to process all of the components of an e-vehicle which require machining. In addition to e-motor housings and the related gearbox covers, auxiliary units such as battery trays to accommodate the energy storage system and compressor, which are used for thermal management in vehicles, are also machined. Due to their size of up to 2x1 m and their thin walls, battery trays are particularly susceptible to vibration. This problem is overcome, chiefly during milling, with the aid of geometric features such as very uneven spacing when cutting and a rigid tool interface created by inputs with optimised interference contours. Having already successfully completed more than 20 battery case projects, GÜHRING is considered a leader in this application. Machining with minimum lubrication also guarantees the long-term sustainability of production. In this area too, both companies have a long track record of successful conventional drivetrain projects. Thermal management presents another challenge in electric vehicles. In the past, conventional air conditioning systems have been powered by combustion engines. For electric vehicles, in future electric compressors will be used as heat and cold pumps. The compressor comprises two coils, the opposing motion of which compresses gas. Small tolerances for the coils ensure that the most efficient compression possible is achieved. For example, the requirements for geometric tolerance are an angularity of 20 µm and a line profile of 8 µm. The smallest surface finish qualities below Rz 4 µm combined with thin-walled surfaces of less than 3 mm and cutting heights of up to 25 mm are typical of this machining task. The solutions are milling tools with minimum cutting pressures. Highly positive rake angles and increased rigidity mean that tolerances are reliably met.

A clear grasp of the challenges for the future

GROB and GÜHRING are dedicated to ensuring that their customers can have all their e-mobility needs met from a single source, anywhere in the world, and act as a professional partner to the worldwide automotive industry in the series production of electric drives. With their strategy of a diversified product portfolio and their ability to offer and supply all the manufacturing processes for electric motors, the partners are fully prepared for dynamic, technological change in automotive drivetrains.

E-MOBILITY

PIONEERING. SUSTAINABLE. MOBILE.

Sustainability, emission-free engines and less dependence on fossil fuels: the mobility of our future will change. E-mobility is a central theme of the energy revolution and electric vehicles are a key component of the transport revolution. E-motors are used in both hybrid vehicles and all-electric vehicles.

As a longstanding supplier to the automotive industry, Gühring has been addressing the challenges of e-mobility since the industry first began switching to electricity. From original equipment and retooling to the reprocessing of tools and tool management, we are known as a single-source provider of professional solutions.

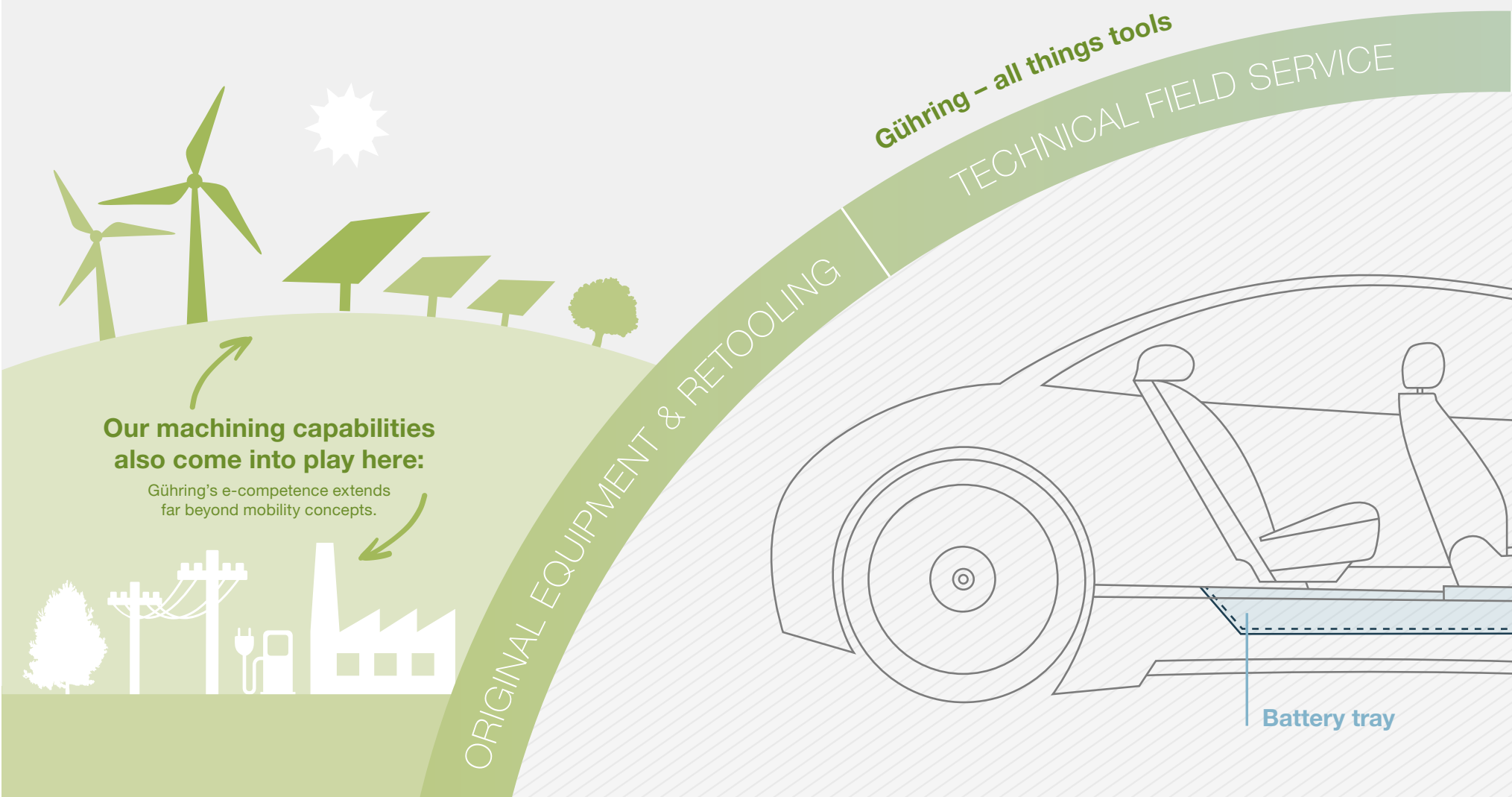

Our machining capabilities also come into play here:

Gühring's e-competence extends far beyond mobility concepts.

Market penetration of e-mobility

Electrified mobility solutions are by no means confined to private mobility. E-mobility is being embraced in the sport segment, goods transport and local public transport.



100% production depth

Gühring combines all the skills involved in tool manufacture under one roof. Here, we help drive and implement trends in the metal industry.

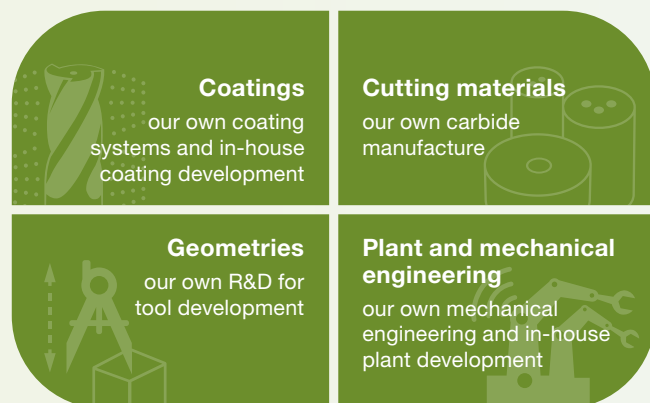

E-MOTOR AUTOMOTIVE

View of component
Gearbox side

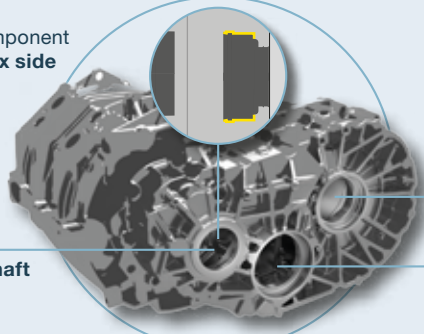

Motor shaft

Drive shaft bearing

Transmission bearing

Eccentric reverse machining

- machining of one side
- process reliability with the aid of rigidity and vibration tests, taking account of real operating speeds

View of component
Stator side

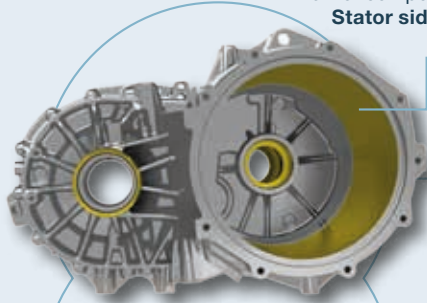

Stator bore

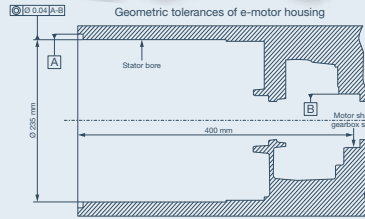

Small diameter tolerances and geometric tolerances

- cost-efficient and precise machining of small diameter tolerances up to IT6
- reliable tool solutions for particularly small geometric tolerances, e.g. concentricity of up to 40 µm with a reference length of over 400 mm
- FEM calculation during tool construction to reduce weight

View of component
Stator side

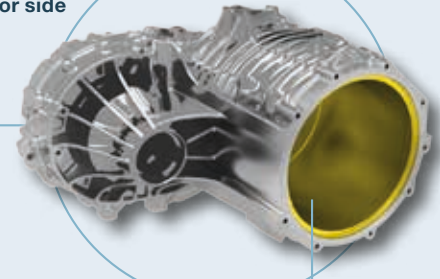

Stator bore

Big diameter – light tools

- small tilting moment
- maximum rigidity with few materials
- minimised machine spindle load

Low-chip machining

- defined chip evacuation away from component, by using special geometries
- avoidance of chip ingress into the component when reaming, drilling and milling
- reduction of rinsing cycles, translating into sustainable manufacture

View of component
Cross-section of
stator bore

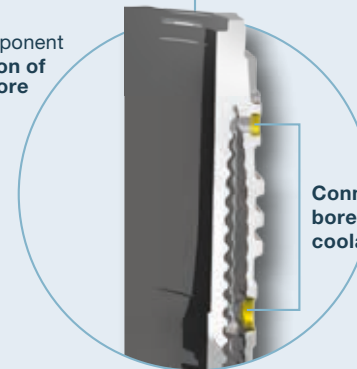

Connecting bores for
coolant duct

REPROCESSING

TOOL MANAGEMENT

E-motor housing

Compressor

Gühring – your worldwide partner

Gühring is nearby, everywhere all over the world. This means we can guarantee first-class support and quick response times. You can be sure that we are never far away.



Market trend of e-mobility

Market share of the different drive systems as percentage of global sales

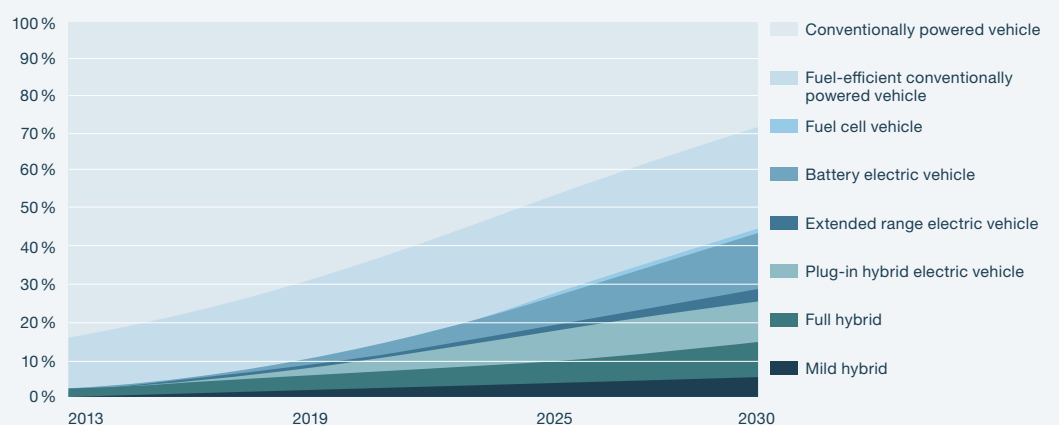

From: STRUKTURSTUDIE BWe mobil, Elektromobilität in Baden-Württemberg

Original equipment & retooling

Powerful partner for new processes

No matter what challenges customers may face when machining their components, Gühring is there to help as a dependable partner with many years of experience and expert know-how. We offer a comprehensive service that is optimally tailored to individual requirements that is designed to accompany users when making an initial selection of tools. We also assume responsibility for the design of individual tool concepts and support the planning and optimisation of production – all based on your particular requirements.

Original equipment

With around 200 employees worldwide and over 20 years of experience, Gühring implements around 600 original equipment projects every year. Our team of experts consisting of engineers, technicians, designers and sales staff support machine manufacturers and users from a wide range of industries worldwide in the design of new tool concepts. As an experienced project partner, we support you from the planning stage through to commissioning and series production.

Retooling

If customers need support with tooling or retooling new or existing machines for a new process, experts from our Retooling department can handle all aspects of project management, ensuring problem-free execution. We design and optimise tools and clamping fixtures and support project partners from the planning stage through to commissioning of their machine. We remain in close contact with planners and machine manufacturers to ensure that all components are perfectly matched to one another.

Users receive a customised package of services – tailored to suit their precise needs. Starting from analysis and scheduling, as well as process configuration, we design and optimise tools and clamping fixtures for the components involved.

We guarantee absolute process reliability for our customers by conducting collision tests – both in simulations and in the machine room. At the final stage, we perform competent NC programming and machining to achieve a successful final acceptance of the machines. Gühring takes care of project management from the planning stage through to commissioning – ensuring that deadlines and individual customer requirements are met.

Contact our original equipment specialists direct:

T +49 75 71 108-0 | F +49 75 71 108-22 225

Winterlinger Strasse 12 | 72488 Sigmaringen-Laiz

200
employees

more than 20 years
of OEM experience

more than 600
projects per year

GÜHRING

THE MACHINING OF TOMORROW.



GÜHRING KG | T +49 74 31 17-0 | F +49 74 31 17-21 279

Herderstrasse 50-54 | 72458 Albstadt | Germany | info@guehring.de | www.guehring.com